

---

---

# AEU-1070-70V

## Dental Implant System

---

---



(AHP-85MB-X)\*

*\*Shown with optional equipment purchased separately*

**OPERATION AND  
MAINTENANCE MANUAL**



**SAFETY PRECAUTIONS**

*Aseptico accepts no liability for direct or consequential injury or damage resulting from improper use, arising in particular through the non-observance of the operating instructions, or improper preparation and maintenance of this product.*

To prevent injury to people and damage to property, please heed relevant warnings and remarks. They are marked as follows:

- **WARNING:** Serious injury or death may result if ignored.
- **CAUTION:** Damage to property or the environment may result if ignored.
- **NOTE:** Important additional information and hints.

- ▲ **WARNING:** The system is supplied non-sterile! Before first use, and before each patient use thereafter, sterilize specified components as recommended in the Cleaning, Maintenance and Sterilization section.
- ▲ **WARNING:** Use for intended purposes only. Failure to observe the operating instructions may result in the patient or user suffering serious injury or the product being damaged, possibly beyond repair. Before using this product, make sure that you have studied and understood the operating instructions.
- ▲ **CAUTION:** Federal law restricts this device to sale by or on the order of a dentist.
- ▲ **CAUTION:** Use of other dental accessories or sub-assemblies from third-party manufacturers is the sole responsibility of the user.
- ▲ **CAUTION:** All repairs are to be performed by authorized service personnel only.
- ▲ **CAUTION:** Always follow these guidelines when operating the unit:
  - Never touch drills, burs, files, or other handpiece tips when they are still rotating.
  - The handpiece should only be attached when the motor has stopped running.
- ▲ **WARNING:** Do not install where there is a risk of an explosion. The system is not intended for operation in the presence of flammable anesthetics or gases.
- ▲ **WARNING:** All handpieces have inherent inefficiencies that can lead to torque variations. Routine calibration is recommended, even if using the same handpiece or whenever a handpiece is changed. If further verification of torque accuracy is desired, then it is suggested that a torque wrench be used.
- ▲ **WARNING:** Always comply with the handpiece and implant/file manufacturers' instructions regarding maximum speeds, torques, forward and reverse directions, and use of all instrumentation, drills, burs, etc., used in endodontics, implantology, and other oral surgery applications.
- ▲ **CAUTION:** The irrigation supply system is designed for use with a saline solution or sterile water. For implants, use only suitable irrigants as recommended by the manufacturer's instructions.

- ▲ **CAUTION:** Connect mains power cable to a properly grounded outlet only.
- ▲ **CAUTION:** The motor is sensitive to shock and may be damaged if dropped or impacted against a hard surface.
- ▲ **WARNING:** Do not disassemble or alter the system motor, console, or foot switch. No modification of the AEU-1070-70V is allowed.
- ▲ **CAUTION:** Use only appliance cord Type C13, 10A per IEC / EN 60320-1. Note: North America, Denmark, Australia, and New Zealand may require hospital grade plugs. Consult local codes.
- ▲ **WARNING:** Do not use this device in conjunction with an electric scalpel or on patients with pacemakers.
- ▲ **CAUTION:** Never connect or disconnect the bag spike to the irrigation bag over the console. Water spilled onto the console can damage the unit.
- ▲ **CAUTION:** It is recommended to always have the patient wear a rubber dam during implant procedures.
- ▲ **WARNING:** Using a different 20:1 handpiece from that recommended can cause significant under- or over-torque.
- ▲ **WARNING:** Do not position the AEU-1070-70V so that the power cord is inaccessible for disconnection during use.



This device has been tested and found to comply with the emissions requirements of IEC 60601-1-2:2001-09. These requirements provide reasonable protection against harmful electromagnetic interference in a typical medical installation. However, high levels of radio-frequency (RF) emissions from electrical devices, such as cellular phones, may disrupt the performance of this device. To mitigate disruptive electromagnetic interference, position this device away from RF transmitters and other sources of electromagnetic energy.

INFORMATION CONCERNING THE ACCURACY AND PRECISION OF THIS PRODUCT MAY BE OBTAINED UPON REQUEST BY CONTACTING ASEPTICO AT THE ADDRESS SHOWN ON THIS PAGE.



P.O. Box 1548 • Woodinville, WA 98072  
 8333 216th Street S.E. Woodinville, WA 98072  
 Phone (425) 487-3157 • Toll Free (800) 426-5913  
 Web: [www.aseptico.com](http://www.aseptico.com)  
 Email: [info@aseptico.com](mailto:info@aseptico.com)

# *Congratulations!*

Your new Aseptico AEU-1070-70V system is one of the finest and most affordable implant motor systems available to the dental profession.

Features include:

- Powerful brushless 40,000 RPM motor for use with an AHP-85MB-X or AHP-85MB-CX 20:1 reduction handpiece.
- Large, easy-to-read touch screen display.
- 8 programmable presets.
- Multi-function foot controller.
- Water-resistant cabinet design helps prevent liquid spills from entering the internal electronics and allows easy clean-up.
- Isolated peristaltic pump chamber prevents leaks from entering the internal electronics.
- Vibration isolated peristaltic pump motor provides extremely quiet operation.
- Large 1000ml saline bag capacity.
- Made in the USA.

This system is engineered to provide many years of reliable service. Please read the instructions provided in this manual to ensure the optimum service from your Aseptico equipment.

Separate manuals may be provided to cover the operation and maintenance of handpieces or other accessories for your unit.

## TABLE OF CONTENTS

**INTENDED USE** . . . . .3

**PACKAGE CONTENTS** . . . . .3

**PURCHASED SEPARATELY** . . . . .3

**SYSTEM SETUP** . . . . .5

**CONTROL PANEL** . . . . .8

**OPERATION** . . . . .9

**MAINTENANCE AND STERILIZATION** . . . . .10

**MESSAGES** . . . . .11

**WASTE DISPOSAL** . . . . .11

**CONTRAINDICATIONS** . . . . .11

**ADVERSE REACTIONS** . . . . .11

**TROUBLESHOOTING** . . . . .12

**WARRANTY** . . . . .12

**FUSE REPLACEMENT** . . . . .12

**SYMBOL DESCRIPTIONS** . . . . .13

**SPECIFICATIONS** . . . . .13

**CUSTOM PRESETS** . . . . .14

## INTENDED USE

The AEU-1070-70V is a drive system for instruments and tools used in dentistry for implant procedures. The system includes an irrigation supply and a wide range of user controls designed to provide precision drilling during osteotomy preparation and implant placement.

**RX: FEDERAL LAW RESTRICTS THIS DEVICE TO SALE BY OR ON THE ORDER OF A DENTIST**

## PACKAGE CONTENTS

- Electronic Control Console (P/N 120407-01)
- AE-230A-40 Autoclavable 40K Brushless Micromotor
- Autoclavable Motor Holder (P/N 461561)
- AE-70V2 Multi-function Foot Controller
- AE-24 Autoclavable Irrigation Tubing Set
- AE-24-PUMP Peristaltic Pump Tubing Set (10 pieces)
- Irrigation Bag Hanger Rod (P/N 461541)
- Hospital-grade Power Cord (P/N 840079)

## PURCHASED SEPARATELY

- AHP-85MB-X or AHP-85MB-CX 20:1 Mont Blanc® Reduction Contra-Angle Handpiece
- Replacement AE-24 Autoclavable Irrigation Tubing Set
- Replacement AE-24-PUMP Peristaltic Pump Tubing (10 Pieces)
- Replacement AE-24-BOT Autoclavable Irrigation Tubing Set for Bottles

---

*Mont Blanc® is a registered trademark of Anthogyr.*

**PACKAGE CONTENTS**



## SYSTEM SETUP

This section provides step-by-step instructions for setting up the unit.

**i** The handpiece, motor/cord assembly, and irrigation tubing set must be sterilized before each procedure as instructed in the Maintenance and Sterilization section (page 10).

1. Unpack the unit and identify each of the components shown to the left (page 4).
2. Insert the bag hanger **A** into the hole on top of the console. Make sure that the tab **B** on the hanger fully enters into the slot **C** on the console, locking the hanger in position.

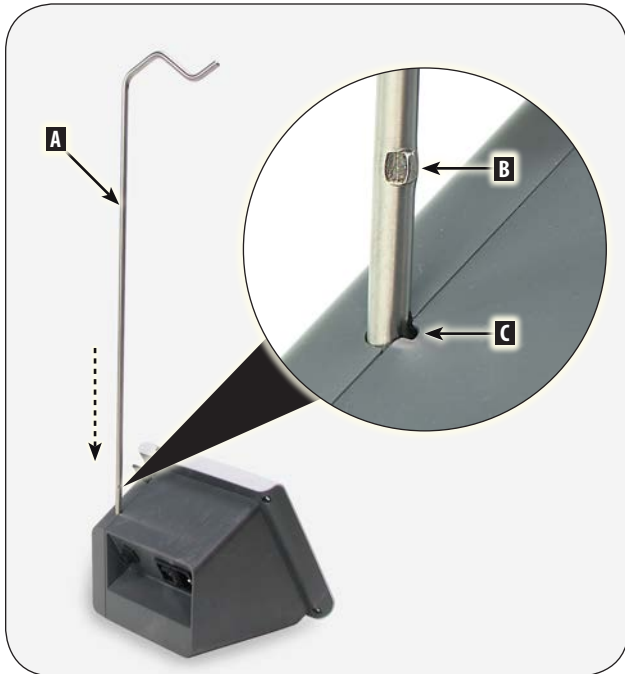

3. Plug the power cord **A** into the power inlet on the back of the console, then plug the other end of the power cord into a hospital-grade, grounded electrical outlet.



4. Connect the foot controller plug **A** to the socket on the back of the console.

**i** The foot controller plug is “keyed” to the socket and can only be inserted in one position, with the notch **B** pointing to the left. Hold the plug against the socket and rotate it until you feel the plug enter the socket, then turn the locking sleeve clockwise until it clicks to secure the connection.



5. Connect the motor plug **A** to the socket on the front of the console.

**i** The motor plug is “keyed” to the socket and can only be inserted in one position, with the larger tab **B** pointing up. Hold the plug against the socket and gently rotate it until you feel the plug enter the socket, then turn the locking sleeve clockwise to secure the connection.



6. Install an AHP-85MB-X or AHP-85MB-CX 20:1 handpiece **A** (sold separately) onto the motor **B**.

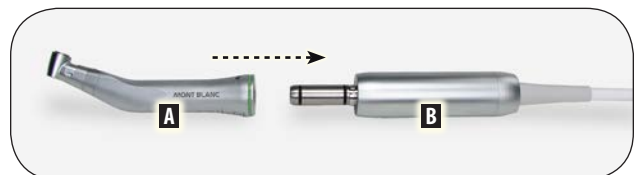



**SYSTEM SETUP (Continued)**

7. Place the motor/handpiece onto the cradle **A**.

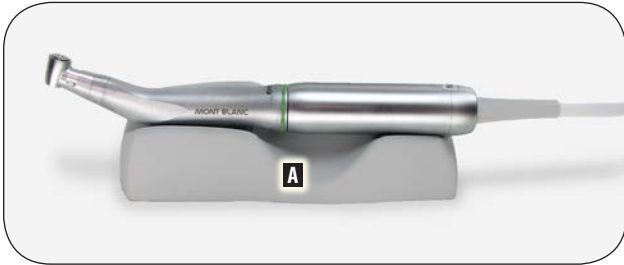

8. Pull the lever **A** on top of the console to release the pump door.



9. Pull the pump door **A** fully open.



10. While installing the irrigation tubing it will be helpful to be able to identify the bayonet **A**, large tubing connector **B**, peristaltic tube segment **C**, Luer connector **D**, and the small tubing connector **E**.

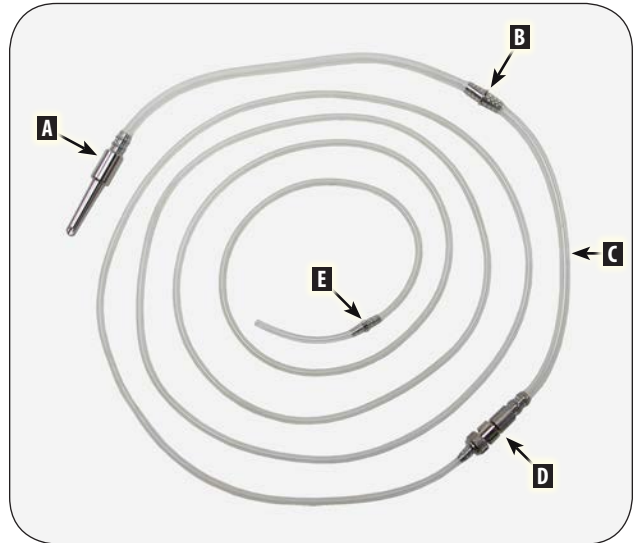

11. Two red arrows **A** on the pump door indicate the path to install the irrigation tubing. Start by threading the peristaltic tube segment through the top slot **B** in the pump door. The large tubing connector **C** should be above the slot, as shown.

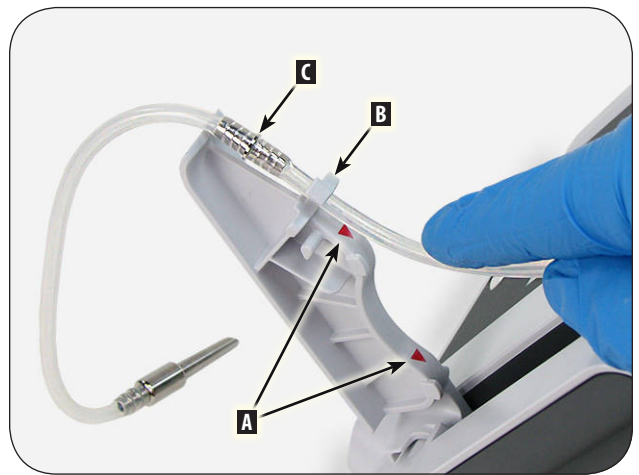

12. Pull the tube down through the top slot until the large tubing connector **A** seats securely into the slot.

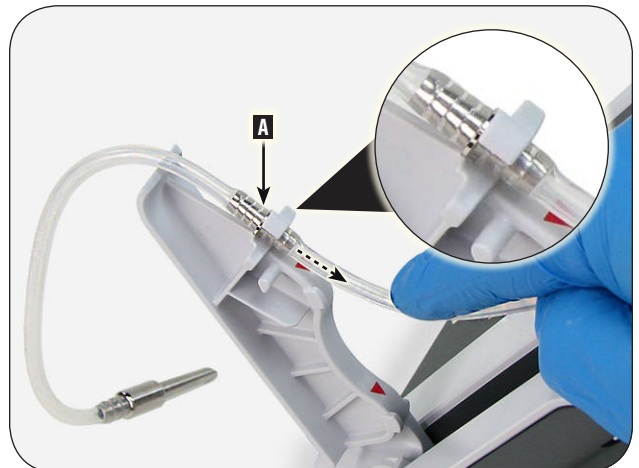

13. Following the next arrow on the door, thread the peristaltic tube segment through the bottom slot **A** on the pump door.



14. With one hand, pull the irrigation tube tightly from the bottom of the pump door **A**. Use the other hand to guide the irrigation tube into the notch **B** on the console while closing the pump door.



15. Attach the small end of the irrigation tube **A** to the handpiece irrigation fitting, following the instructions that came with your handpiece. Attach the irrigation tube to the motor cable at evenly spaced intervals using the AHP-03 clips **B** provided in the AE-24 tubing set bag.



16. Hang a saline bag (1000ml max.) with the port **A** pointing towards the rear of the console.



17. Before you spike the saline bag, swing it away from the console to prevent liquid from dripping on the console, then spike the saline bag with the bayonet **A**. Wipe up any spills on the console immediately.



18. Press the power switch **A** on the rear of the console to the on (I) position to turn the unit on.



## CONTROL PANEL

This section provides descriptions of the control panel touch-screen features and functions.

### Home Screen

The home screen displays the name of the active preset and the current settings for each of the adjustable parameters.

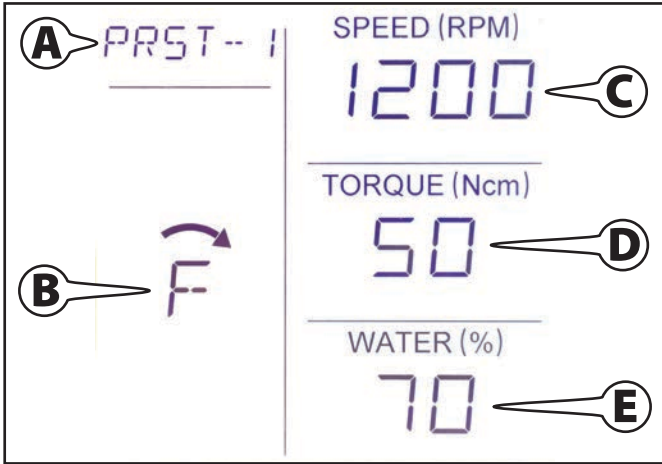

**A PRESET** — This segment of the screen displays the active preset name. Press here repeatedly to cycle through the 8 presets sequentially. Below is a table of the factory settings for each preset.

PRESET	DIRECTION	SPEED (RPM)	TORQUE (Ncm)	WATER (%)
PRST-1	FORWARD	1200	50	70
PRST-2	FORWARD	800	50	70
PRST-3	FORWARD	15	35	0
PRST-4	FORWARD	15	50	0
PRST-5	REVERSE	25	50	0
PRST-6	FORWARD	20	30	0
PRST-7	FORWARD	21	40	0
PRST-8	FORWARD	22	50	0

**B MOTOR DIRECTION** — This segment of the screen displays the current motor rotation direction. Press here to alternate between forward (F) and reverse (R).

**C SPEED** — This segment of the screen displays the current motor speed setting in revolutions per minute (RPM). Press here to open the speed adjustment screen, then press the ▲ and ▼ buttons to adjust the speed setting, between 15 and 2000 RPM. Press anywhere on the right side of the screen to return to the home screen.

**D TORQUE** — This segment of the screen displays the current torque setting for the handpiece in Newton centimeters (Ncm). Press here to open the torque adjustment screen, then press the ▲ and ▼ buttons to adjust the torque setting, between 5 and 70 Ncm. Press anywhere on the right side of the screen to return to the home screen.

**i** When the Speed is set to 500 RPM or above, the system automatically switches to "Torque-Limit" mode. When the Speed is set below 500 RPM, the system automatically switches to "Torque Auto-Stop" mode.

TORQUE-LIMIT MODE (Speed setting ≥500 RPM)
A torque warning tone will sound when the handpiece torque reaches 75% of the torque setting. The handpiece will slow down when a load greater than the torque setting is reached. The handpiece will resume speed once the load is removed.
TORQUE AUTO-STOP MODE (Speed setting <500 RPM)
A torque warning tone will sound when the handpiece torque reaches 75% of the torque setting. The handpiece will stop one second after the handpiece reaches the torque setting. The handpiece will resume operation once the footpedal is released and reapplied.

**i** Pressing the Torque screen segment **D** also activates the Factory Restore and Calibration screens, as described in the sections below.

**E WATER** — This segment of the screen displays the current irrigation flow setting in percentages (%). Press here to open the flow adjustment screen, then press the ▲ and ▼ buttons to adjust the flow setting in 10% increments. A setting of 0% turns irrigation off. Press anywhere on the right side of the screen to return to the home screen.

### Saving Presets

The Preset segment **A** of the screen will flash if you have made any adjustments to the current preset. To save the adjustments that you have made to the current preset, press and hold the flashing Preset segment **A** of the screen until you hear a beep. To clear the adjustments you have made to the current preset, simply press and immediately release the flashing Preset segment **A** of the screen. You may write down the settings for your custom presets in the blank tables on page 14, if desired.

### Factory Restore

To restore all presets to their factory settings:

1. Press the Torque segment **D** of the home screen.
2. Press and hold the "CAL" button that appears between the ▲ and ▼ buttons until you hear a beep.
3. Press and hold the flashing "RECALL" button that appears in the Preset segment **A** of the screen until you hear another beep. The factory settings have been restored for all 5 presets (all user modified settings have been erased).
4. To cancel the factory restore procedure, press anywhere on the right side of the screen before completing step 3 above.



## Calibrating the Handpiece

Because the mechanical condition of motors and handpieces changes over time, it is recommended that you calibrate the handpiece periodically and every time that you change handpieces:

1. Insert a bur or drill into the handpiece.
2. Press the Torque segment **(D)** of the home screen.
3. Press the "CAL" button that appears between the ▲ and ▼ buttons. The CAL button will flash as the calibration process steps the motor through several speed changes.



When complete, the CAL button will stop flashing if the calibration was successful. If the CAL button continues to flash after the motor stops, calibration has failed. Repeated failures can indicate a dirty, damaged or defective handpiece and/or motor in need of repair or replacement.

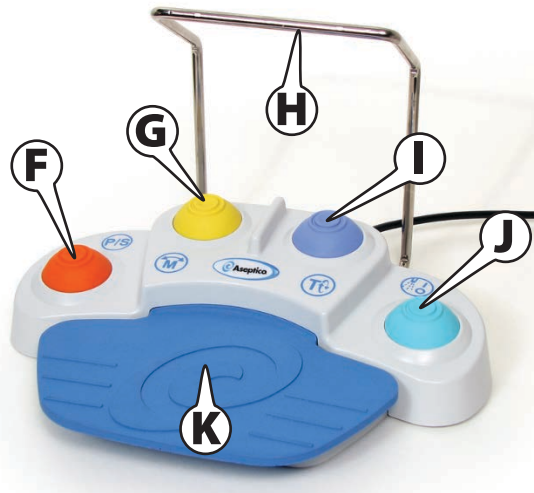

## OPERATION

### AE-70V2 Foot Controller

The AE-70V2 foot controller provides multiple-function control of the system.



- (F) PRESET** — Press repeatedly to step through each of the 5 presets. This provides the same function as pressing the Preset segment **(A)** (page 8) on the touch screen. 
- (G) MOTOR DIRECTION** — Press to alternate between forward and reverse. This provides the same function as pressing the Motor Direction icon **(B)** (page 8) on the touch screen. 
- (H) HANDLE** — Use to manually position the foot controller. Install the handle by inserting the handle prongs into the holes on the rear of the foot controller. 

- (I) TORQUE STEP-INCREASE** — Press to increase the torque setting in 2 Ncm steps for a maximum of 5 consecutive steps (or until the maximum torque setting is reached). On the sixth press (or the press after the maximum torque setting is reached), the torque setting will return to the original, lowest setting. 
- (J) WATER ON-OFF / STEP-INCREASE** — Press to switch the irrigation pump on-off. When the pump is switched off, the Water segment **(E)** (page 8) of the screen will display "— —" instead of 0%. Press and hold this button to step through the water settings in +10% increments; the steps occur at 1-second intervals with a beep sounding to signal each step. 
- (K) VARIABLE SPEED PEDAL** — This pedal activates the motor and irrigation pump simultaneously and provides variable speed control of the motor (up to the current speed setting displayed on the console). The motor speed varies in proportion to how far down you depress the pedal. The irrigation pump rate is not variable and it is activated at the current water setting whenever this pedal is depressed.



## MAINTENANCE AND STERILIZATION

Failure to adhere to the following instructions or blatant misuse of the device and/or related components will be considered abuse of the device and will void the warranty.

 Call Aseptico at 1-800-426-5913 with any questions on sterilization procedures.

### Handpiece

Follow the instructions provided with the handpiece for complete cleaning, maintenance and sterilization instructions.

### Motor & Cord Assembly

 **CAUTION:** The motor is sensitive to shock. Do not drop or impact the motor against a hard surface.

**WARNING:** Do not oil or lubricate the motor.

**CAUTION:** Do not allow oil from the handpiece to drain into the motor. After lubricating and before sterilizing the handpiece, stand it on a paper towel to allow excess oil to drain out of the handpiece.



**WARNING:** Do not attach a handpiece to the motor while the motor is running.

**WARNING:** Do not bend the motor cord sharply.

**WARNING:** Do not attempt to disassemble the motor or motor connector.

**WARNING:** Use of a sterilization method or temperatures other than what are prescribed below may damage components or present a risk of cross-contamination between patients.

**CAUTION:** Do not soak or submerge the motor in any liquid.

**CAUTION:** Do not use ultrasonic cleaners.

**CAUTION:** Do not use cold sterilization or dry heat.

1. Brush off debris from the motor and cord.
2. Thoroughly clean the motor and cord with a moist cloth or towel to remove any remaining signs of debris. Avoid pulling the cord away from the motor. Always wipe towards the motor.

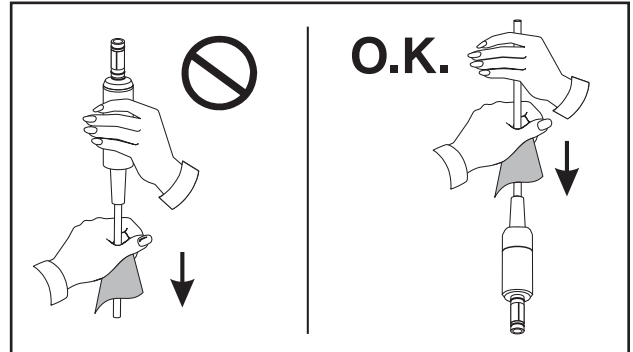

3. Install the provided autoclaving plug **A** onto the end of the motor cord connector.



4. Sterilize the motor and cord assembly using one of the STERILIZATION METHODS listed below (A, B or C).

 Loosely coil the motor cord when autoclaving. Avoid sharply bending the cord.

**STERILIZATION METHODS:**

**Wrapped Sterilization** — Place in an appropriately sized sterilization pouch and seal.

**A. Standard autoclaving** (Gravity displacement method)  
**Time:** 15 min  
**Temperature:** 132° C (270° F)  
**Dry time:** 30 minutes

**B. Pre-vacuum** (Dynamic air removal method)  
**Time:** 4 minutes  
**Temperature:** 132° C (270° F)  
**Dry time:** 40 minutes

**Flash Sterilization** — For immediate use only.

**C. Unwrapped standard autoclaving** (Gravity displacement method)  
**Time:** 10 minutes  
**Temperature:** 132° C (270° F)  
**Dry time:** No dry time is required for flash sterilization.

**Silicone Water Lines**

1. Flush the tubing with clean water for 30 seconds after each use. Do not use any disinfectants on the tubing.
2. Sterilize the tubing:

**Wrapped Sterilization** — Place in an appropriately sized sterilization pouch and seal.

**Standard autoclaving** (Gravity displacement method)  
**Time:** 30 min  
**Temperature:** 132° C (270° F)  
**Dry time:** 30 minutes

**Console and Foot Controller**

1. Clean the exterior of the console and foot controller by wiping with a soft cloth moistened with mild detergent or 1:10 bleach solution (1-part bleach to 9-parts water). Use of solvents or other solutions may cause damage and void the warranty.

**MESSAGES**

**System Messages**

1. When the system is powered on, the software part number and version will be displayed briefly on the console screen.

**Error Messages**

NONE

**Fault Messages**

NONE

**WASTE DISPOSAL**

Dispose of all medical waste products, residues, etc. in accordance with your local, state and country laws. Dispose of the AEU-1070-70V and accessories at the end-of-life in accordance with your local, state and country laws.

**CONTRAINDICATIONS**

None known

**ADVERSE REACTIONS**

None known

## TROUBLESHOOTING

### Console does not light up when turned on:

- Check power cord connection.
- Check fuse. If blown, see *Fuse Replacement* (page 12)

### Console lights up when turned on, but handpiece does not operate:

- Check motor plug connection.
- Check foot controller connection.
- Depress the main foot controller switch.
- Increase the speed setting.
- Increase the torque setting.
- Check that the connector pins in the plug socket are not bent.
- Check that the rotary tool is properly seated in the handpiece and that the latch/collet is closed.

### No water flow from pump to handpiece:

- Check that the water setting is 10% or above.
- Check that water container seal is completely punctured.
- Make sure the irrigation tubing is properly installed in pump door and flow is in the correct direction.

### Motor slowing down or sluggish:

- Check for dirty, under-lubricated handpiece.
- Check if handpiece lubricant is draining into motor.

### Display error:

- Switch off power, wait 5 seconds, then switch back on to reset..

### Pump leaking:

- Replace the peristaltic pump segment of the irrigation line with a new one from the extra tube set provided.

## WARRANTY

Aseptico Inc. warrants this product against defects in material or workmanship for a period of two (2) years, from date of original invoice. Some handpieces are warranted for one year under the same conditions. Other handpieces and expendable components, such as air turbines and light bulbs, are covered by shorter warranty periods, or have no warranty. Aseptico's sole obligation under product warranty is (at its sole option and discretion) to repair or replace any defective component or product in part or whole. Aseptico Inc. shall be the sole arbiter of such action.

In the event of alleged defect under warranty, the purchaser is to notify Aseptico's Customer Service Department promptly. Customer Service will provide instructions, usually directing that the product be returned for service. Shipment to Aseptico and the cost thereof is always the responsibility of the purchaser.

Accidental misuse, inappropriate installation, or failure to perform directed maintenance voids the warranty. Deliberately defacing, modifying, or removing the serial number voids the warranty.

Aseptico Inc. does not assume, under this warranty, any risks or liabilities arising from the clinical use of its products, whether or not such use involves coincidental utilization of products manufactured by others.

## FUSE REPLACEMENT



### WARNING



Switch off the power and unplug the unit before following the steps below.



The system features auto-sensing global voltage compatibility. The fuse indicated is correct for 100V-240V 50/60 Hz line voltage.

1. Remove the fuse holder from the power inlet socket by prying it out using two small blade screwdrivers, one on the top **A** and the other on the bottom **B** of the fuse holder.

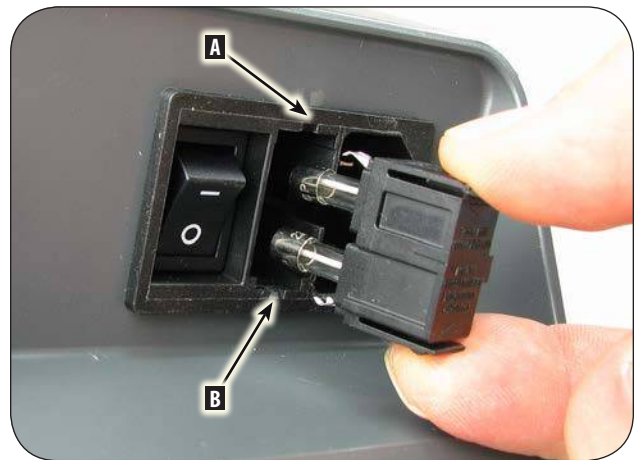

2. Replace both fuses in the fuse holder with the same type and rating: **5 x 20mm, 1.6A, 250V slow-blow**.
3. Reinstall the fuse holder.



**SYMBOL DESCRIPTIONS**

	Consult Instructions For Use
	Type B Equipment
	Caution – Consult Accompanying Documents
	Alternating Current
	Fuse Rating
	Dangerous Voltage
	Motor Direction
	Preset Step Through
	Torque Step Through
	Pump On-Off/Step Through
	Dispose Of Properly
	Footswitch
	Manufacturer
<b>IPX1</b>	Ingress of Water - Classification-Footswitch
	Protective Earth (Ground)
	Temperature Limitation
	Atmospheric Pressure Limitation
	Humidity Limitation
	Sterilize at 132°C (270°F)
	Authorized European Representative
	Serial Number
	Part Number
	ON-OFF Switch

**SPECIFICATIONS**

**CONSOLE DIMENSIONS:** 19.6 cm W x 18.0 cm D x 16.0 cm H (7.72" W x 7.09" D x 6.30" H)

**CONSOLE WEIGHT:** 1.41 kg (3.11 lbs)

**POWER SOURCE:** 100-240V, 50-60Hz

**CURRENT RATING:** 100V/2A, 240V/2A

**DUTY CYCLE:** 16.7%

**ENVIRONMENTAL CONDITIONS:**

**Operating Temperature:** 10°C to 28°C (50°F to 82.4°F)

**Transport/Storage Temperature:** -20°C to 60°C (-4°F to 140°F)

**Relative Humidity:** 10 to 90% non-condensing

**Altitude:** 0 to 3,000 meters (0 to 9,842 feet)

**Classifications:**

- Class 1 Equipment
- Type B Equipment
- Ordinary Equipment - degree of protection against ingress of water
- Not suitable for use in the presence of a flammable anesthetic mixture with air or with oxygen or nitrous oxide.
- IPX1 - Footswitch

**Manufacturer**



**Aseptico Inc**  
8333 216 St SE  
Woodinville  
WA 98072  
USA



**Advena Ltd**  
Pure Offices  
Plato Close  
Warwick  
CV34 6WE  
UK



MEDICAL ELECTRICAL EQUIPMENT WITH RESPECT TO ELECTRIC SHOCK, FIRE AND MECHANICAL HAZARDS ONLY IN ACCORDANCE WITH UL 60601-1: 1988 +A1+A2, ANSI/AAMI EN 60601-1: 2005/(R)2012 & A1:2012, C1:2009/(R)2012, A2:2010/(R)2012-Pt 1, CAN/CSA C22.2 No 60601-1:14-Pt 1

**CUSTOM PRESETS**

Use the blank tables below to write down your custom preset settings:

PRESET	DIRECTION	SPEED	TORQUE	WATER
PRST-1				
PRST-2				
PRST-3				
PRST-4				
PRST-5				
PRST-6				
PRST-7				
PRST-8				

PRESET	DIRECTION	SPEED	TORQUE	WATER
PRST-1				
PRST-2				
PRST-3				
PRST-4				
PRST-5				
PRST-6				
PRST-7				
PRST-8				

PRESET	DIRECTION	SPEED	TORQUE	WATER
PRST-1				
PRST-2				
PRST-3				
PRST-4				
PRST-5				
PRST-6				
PRST-7				
PRST-8				

PRESET	DIRECTION	SPEED	TORQUE	WATER
PRST-1				
PRST-2				
PRST-3				
PRST-4				
PRST-5				
PRST-6				
PRST-7				
PRST-8				





P.O. Box 310 • Woodinville, WA 98072  
8333 216th Street S.E. Woodinville, WA 98072  
Phone (425) 487-3157 • Toll Free (800) 426-5913  
Web: [www.aseptico.com](http://www.aseptico.com)  
Email: [info@aseptico.com](mailto:info@aseptico.com)